

Single Motor Receiver

1. TECHNICAL SPECIFICATIONS

Power: AC120V(60Hz)

Rated load: do not exceed 400 watts

Protection Index: IP44

The receiver can be compatible with 15 remotes at most.

The receiver will cut off electricity after working 4 minutes continuously.

2. WIRES CONNECT

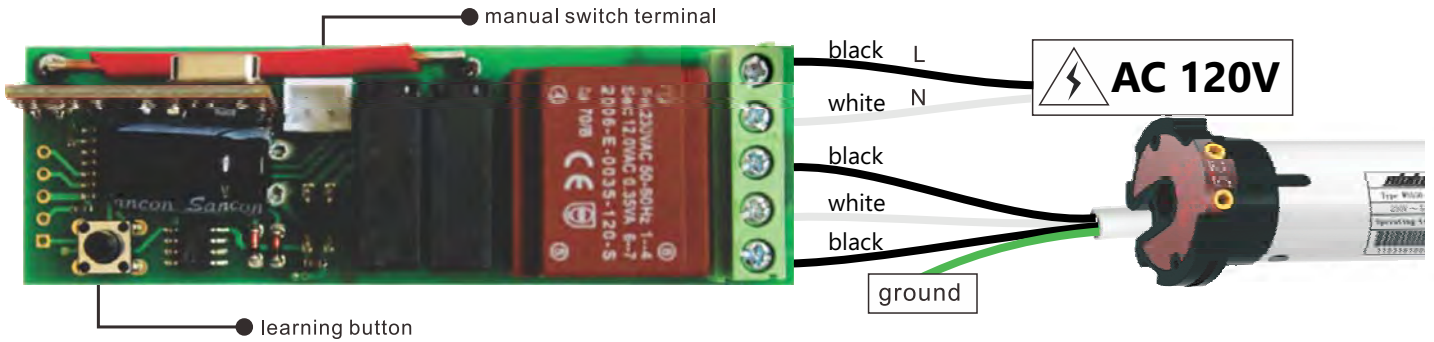

3. CODE LEARNING

Way A



Power on, the motor will vibrate.

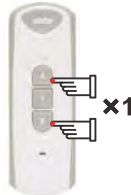

Press UP and DOWN buttons simultaneously.

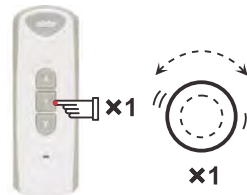

Press the STOP button once within 10s, the motor will vibrate.



You can control the motor by the remote.

Way B

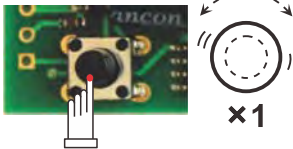

Switch on the power, press receiver's learning button, the motor vibrates once.

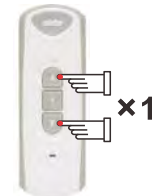

Press remote's UP and DOWN buttons simultaneously.

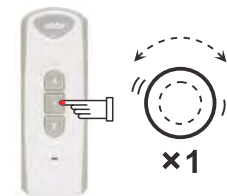

Press remote's STOP button once, the motor vibrates.



The motor can be controlled by the remote.

4. COPY

Note: Remote B can control the tubular motor after it learns code from remote A.

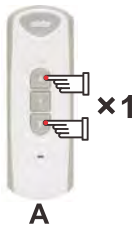

Press remote A's UP and DOWN buttons once simultaneously.

x 8



Press remote A's STOP button 8 times, the motor vibrates once.

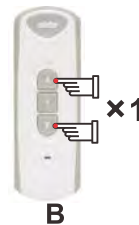

Press remote B's UP and DOWN buttons once simultaneously.

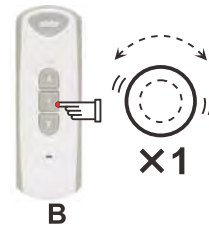

Press remote B's STOP button once, the motor vibrates. Now you can control the motor also by remote B.

5. CODE DELETING

Note: No remote can control this tubular motor after code deleting unless you reset.

Way A

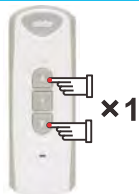

Press remote's UP and DOWN buttons once simultaneously.



Press remote's STOP button 6 times.

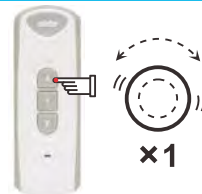

Press remote's UP button once, the motor vibrates.



Code deleting is successful, no remote can control this motor.

Single Motor Receiver

Way B

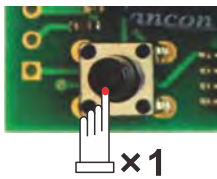

Press the receiver's learning button until the motor vibrates twice. The code is deleted and no remotes can control this motor.

Way C



Press remote's UP and DOWN buttons once simultaneously.



Press remote's STOP button 7 times.



Press remote's UP button, the motor vibrates once.



The remote you are operating is deleted and cannot control the motor.

6. DIRECTION CHANGE

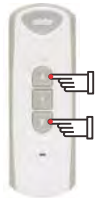

Press remote's UP and DOWN buttons once.



Press remote's STOP button 6 times.



Press remote's DOWN button once, the motor vibrates.



The motor's running direction is changed.

7. SET STEP BY STEP FUNCTION



Press remote's UP and DOWN buttons once.



Press remote's STOP button once.



Press remote's UP button once, the motor vibrates once.

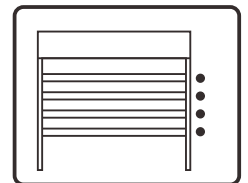

The motor will run step by step.

If the motor is in vibration state, press remote's UP or DOWN button for 3 seconds, the motor will run continuously. Press the STOP button, the motor will change into vibration state.

8. DELETE STEP BY STEP FUNCTION



Press remote's UP and DOWN buttons once.



Press remote's STOP button once.



Press remote's DOWN button once, the motor vibrates once.

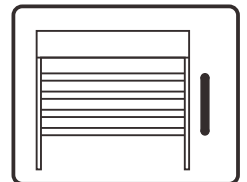

The motor will run continuously.

9. WALL SWITCH

A wall switch can be connected to the receiver to control the tubular motor. The manual switch is to connect Door Bell Switch. With manual switch, the tubular motor can achieve UP-STOP-DOWN-STOP-UP sequence.

! ANNOUNCEMENT

The setting may fail due to other signal interference. In this case, please reset.

The remote RE101 is taken as an example in this instruction. The receiver is compatible with other rolling codes remotes also.

If remote's battery is in low power, please replace it.

The receiver is of high voltage, please do not place it in humid conditions.

Children should be supervised to ensure that they do not play with the appliance.

Working temperature: -10 °C to +55 °C.

All products are as per real subjects. There will be no prior notification if any change in appearance, color, functions etc.