

# TYB002 Solar Panel Manual

## 1. PRODUCT APPEARANCE



Front



Backside

## 2. PRODUCT FEATURES

Monocrystalline silicon solar panel (high photoelectric conversion efficiency and good stability; this is the highest photoelectric conversion efficiency of all types of solar panels at present).

## 3. TECHNICAL DATA

Open-circuit voltage of solar panel: 17V

Built-in 6 rechargeable lithium batteries

Battery capacity: 4400mAh

Adapter can be fully charged in 6 hours

Output interface: waterproof plug

Discharge temperature: -20°C to 65°C

Applicable motor type: WSERD40 or WSERD50

Protection Index: IP40

Output power: 4w

Output voltage: 11.1V

Lifetime: charge/discharge 500 times

Power adapter specs: output DC16.8V/1A  
DC3.5x1.35

Charging temperature: 0°C to 45°C

Working temperature: 0°C to 45°C

Overall dimensions: 546mmx89.6mmx32mm

## 4. BATTERY CHARGING SOLUTION



B. Adaptor

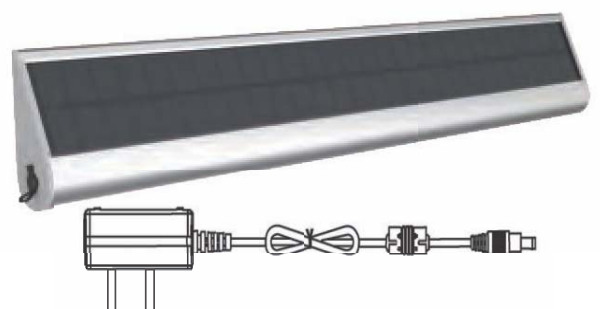

## TYB002 Solar Panel Manual

### 5. INSTALLATION

#### A. Horizontal Installation

##### STEEL STRUCTURE INSTALLATION DIAGRAM

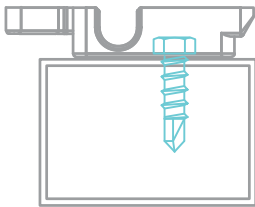

Figure 1

Fix the bracket to the steel structure with M5.5 x 38 self drilling screws, as shown in Figure 1.

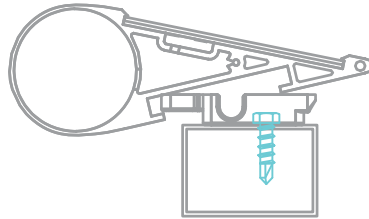

Figure 2

Turn the solar panel downward as shown in Figure 2, then push it into the slot from left to right.

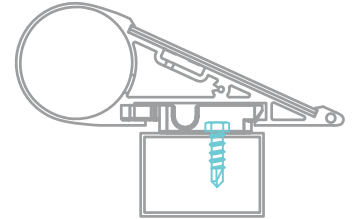

Figure 3

The final installation is completed, as shown in Figure 3.

##### CONCRETE WALL STRUCTURE INSTALLATION DIAGRAM

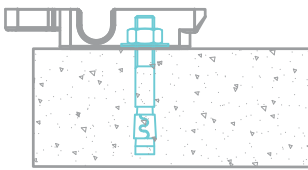

Figure 1

Fix the bracket on the concrete wall with M6 expansion screws.

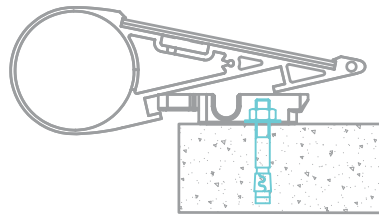

Figure 2

Turn the solar panel downward as shown in Figure 2, then push it into the slot from left to right.

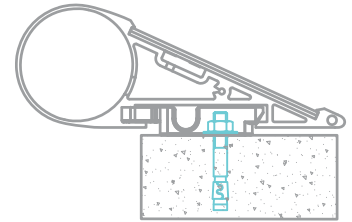

Figure 3

The final installation is completed, as shown in Figure 3.

#### B. Vertical Installation

##### STEEL STRUCTURE INSTALLATION DIAGRAM

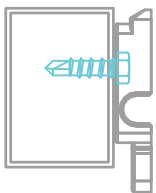

Figure 1

Fix the bracket on the steel structure with M5.5 x 38 self drilling screws, as shown in Figure 1.

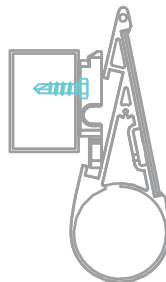

Figure 2

As shown in Figure 2, rotate the solar panel down to the proper angle, and then push it into the slot from bottom up.

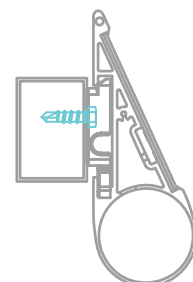

Figure 3

The final installation is completed, as shown in Figure 3.

# TYB002 Solar Panel Manual

## CONCRETE WALL STRUCTURE INSTALLATION DIAGRAM

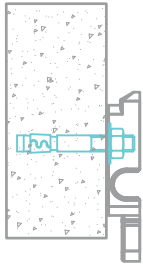

Figure 1

Fix the bracket on the concrete wall with M6 expansion screws.

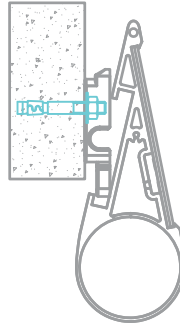

Figure 2

Turn the solar panel downward as shown in Figure 2, then push it into the slot from bottom up.

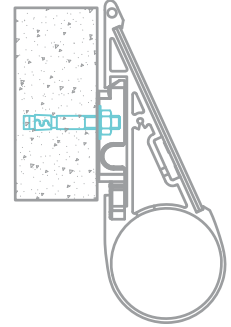

Figure 3

The final installation is completed, as shown in Figure 3.

## 6. ANNOUNCEMENTS

1. Extension cable can be used if needed, but the longer the cable, the more voltage drop. Please ask your supplier for professional advice before using extension cable.
2. You are strongly recommended to clean solar panel's surface to get good exposure from the sun.
3. Any problems you encounter, please reference manual, or ask for professional advice.
4. Keep the product away from children to avoid any hazard.
5. Please remember to respect the local regulations - hand in the non-working electrical equipment to an appropriate waste disposal center. The packaging material is recyclable. Dispose of the packaging in an environmentally friendly manner and make it available for the recyclable material collection-service.
6. Any improvements to the product will not be notified in advance.